

# Service Manual

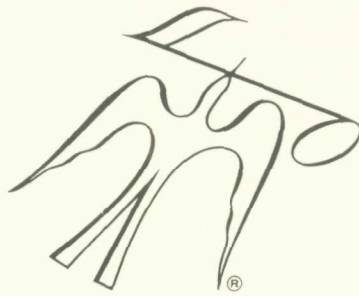

# THE FISHER<sup>®</sup>

## Ambassador

MODEL A-69 Wa

PRICE \$1.00

FISHER RADIO CORPORATION • LONG ISLAND CITY 1 • NEW YORK

(c) [www.fisherconsoles.com](http://www.fisherconsoles.com)

**CAUTION:** This is a FISHER precision high-fidelity instrument. It should be serviced only by qualified personnel — trained in the repair of transistor equipment and printed circuitry.

### EQUIPMENT AND TOOLS NEEDED

The following are needed to completely test and align this high-fidelity instrument.

#### Test Instruments

Vacuum-Tube Volt-ohmmeter DC VTVM  
Audio (AC) Vacuum-Tube Voltmeter (AC VTVM)  
Oscilloscope (Flat to 100 kc minimum)  
Audio (Sine-wave) Generator  
Intermodulation Analyzer  
Sweep (FM) Generator (88 to 108 mc)  
Marker Generator  
Multiplex Generator (preferably with RF output — FISHER Model 300 or equal).

#### Miscellaneous

Adjustable-Line-Voltage Transformer or line-voltage regulator  
Load Resistors (2) — 8-ohm, 50-watt (or higher)  
Stereo source (Turntable with stereo cartridge or Tape Deck)  
Speakers (2) Full-range, for listening tests  
Soldering iron (with small-diameter tip) fully insulated from power line.

### PRECAUTIONS

Many of the items below are included just as a reminder — they are normal procedures for experienced technicians. Shortcuts can be taken but often they cause additional damage — to transistors, circuit components or the printed-circuit board.

**Soldering**—A well-tinned, hot, clean soldering iron tip will make it easier to solder without damage to the printed-circuit board or the many many circuit components mounted on it. It is not the wattage of the iron that counts — it is the heat available at the tip. Low-wattage soldering irons will often take too long to heat a connection — pigtail leads will get too hot and damage the part. Too much heat, applied too long, will damage the printed-circuit board. Some 50-watt irons reach temperatures of 1,000° F — others will hardly melt solder. Small-diameter tips should be used for single solder connections — larger pyramid and chisel tips are needed for larger areas.

- When removing defective resistors, capacitors, etc., the leads should be cut as close to the body of the circuit component as possible. (If the part is not being returned for in-warranty factory replacement it may be cut in half — with diagonal-cutting pliers — to make removal easier.)
- Special de-soldering tipleths are made for unsoldering multiple-terminal units like IF transformers and electrolytic capacitors. By unsoldering all terminals at the same time the part can be removed with little chance of breaking the printed-circuit board.
- Always disconnect the chassis from the power line when soldering. Turning the power switch OFF is not enough. Power-line leakage paths, through the heating element, can destroy transistors.

**Transistors**—Never attempt to do any work on the transistor amplifiers without first disconnecting the AC-power linecord — wait until the power supply filter-capacitors have discharged.

- Guard against shorts — it takes only an instant for a base-to-collector short to destroy that transistor and possibly others direct-coupled to it. [In the time it takes for a dropped machine screw, washer or even the screwdriver, to glance off a pair of socket terminals (or between a terminal and the chassis) a transistor can be ruined.]
- DO NOT bias the base of any transistor to, or near, the same voltage applied to its collector.
- DO NOT use an ohmmeter for testing transistors. The voltage applied through the test probes may be higher than the base-emitter breakdown voltage of the transistor.

**Output Stage and Driver**—Replacements for output and driver transistors, if necessary, must be made from the same beta group as the original type. The beta group is indicated by a colored dot on the mounting flange of the transistor. Be sure to include this information, when ordering replacement transistors.

- If one output transistor burns out (open or shorts), always remove all output transistors in that channel and check the bias adjustment, the control and other parts in the network with an ohmmeter before inserting a new transistor. All output transistors in one channel will be destroyed if the base-biasing circuit is open on the emitter end.

- When mounting a replacement power transistor be sure the bottom of the flange, the mica insulator and the surface of the heat sink are free of foreign matter. Dust and grit can prevent perfect contact. This reduces heat transfer to the heat sink. Metallic particles can puncture the insulator and cause shorts — ruining the transistor.

- Silicone grease must be used between the transistor and the mica insulator and between the mica and the heat sink for best heat conduction. Heat is the greatest enemy of electronic equipment. It can shorten the life of transistors, capacitors and resistors. (Use Dow-Corning DC-3 or C20194 or equivalent compounds made for power transistor heat conduction.)

- Use care when making connections to speakers and output terminals. Any frayed wire ends can cause shorts that may burn out the output transistors — they are direct-coupled to the speakers. There is no output transformer — nothing to limit current through the transistors except the fuses. To reduce the possibility of shorts at the speakers, lugs should be used on the exposed ends — at least the ends of the stranded wires should be tinned to prevent frayed wire ends. The current in the speakers and output circuitry is quite high. Any poor contact or small-size wire, can cause power losses in the speaker system. Use 14 or 16 AWG for long runs of speaker-connecting wiring.

**DC-Voltage Measurements**—These basic tests of the transistor circuitry are made without the signal generator. Without any signal input measure the circuit voltages — as indicated on the schematic. The voltage difference between the base and the emitter should be in the millivolt range — a sensitive DC meter is needed for these readings. A low-voltage range of 1 volt, full scale — or lower — is needed.

**Audio-Voltage (gain) Measurements**—The schematic and printed-circuit board layout diagrams are used. Input signals are injected at the proper points — found most quickly by using layout of the printed-circuit board instead of the schematic. An AUDIO (AC) VTVM connected to the test points should indicate voltages close to those values shown in the boxes on the schematic. Many of the signal levels in the input stages are only a few millivolts — they can not be read on the AC ranges supplied on most Vacuum-Tube AC/DC Volt-ohmmeters (VTVMs). Even with a 1-volt range a signal level of 100 millivolts (.1 volt) will be the first 1/10 of the meter scale. A reading of 1 millivolt (.001 volt) will hardly even move the meter needle.

# FM ALIGNMENT INSTRUCTIONS

## Read These Instructions With Extreme Care Before Attempting Alignment.

**CHASSIS:** Turn the TUNING knob completely counterclockwise without forcing. Dial pointer should be at zero index mark on logging scale. If not, reset the dial pointer. Disconnect the external antenna. When using an oscilloscope for alignment, set the AUDIO LEVEL control for no overload, as shown by the proper waveform shape. Set remaining controls as follows: SELECTOR, MONO; MUTING, OFF; POWER, ON.

**SIGNAL GENERATOR:** The signal generator equipment must be able to supply RF  $\pm 22.5$  KC deviation at 400 cps.

**INDICATOR:** DC VTVM, and scope for alignment.

**ALIGNMENT:** Allow the chassis and test instruments to warm up for at least 15 minutes. Adjust the line voltage for 117 volts AC, 50-60 cps. Use fully insulated tools; a small screwdriver for all trimming capacitors.

**NOTES:**—For accurate alignment, signal generator output voltage must be adjusted to produce meter readings within the range specified in the INDICATION column for each step.

Signal generator frequency should be held constant for IF, limiter and ratio detector alignment (Z1 through Z5).

Do not tamper with adjustments on multiplex sub-chassis. These circuits are extremely stable and should require no service other than tube replacement, which does not affect alignment. Multiplex alignment requires special equipment and procedures. We recommend the FISHER MPX-300 Multiplex Generator for all multiplex servicing applications.

## FM ALIGNMENT (Tuner Only)

STEPS	CHASSIS	SIGNAL GENERATOR			INDICATOR	ALIGNMENT	
	TUNING	COUPLING	FREQ.	MOD.	TYPE CONNECTION	ADJUST	INDICATION
1	Point of no signal and no interference	FM generator connected to TEST POINT 1 through 0.5 pF (or less), clipped to wire insulation or "gimmick".	10.7 MC	None	Connect DC VTVM to TEST POINT 2	Z1, Z2, Z3 and Z4 top and bottom for maximum indication	Between —2 and —5 volts
2	Point of no signal and no interference	FM generator connected to TEST POINT 1 through 0.5 pF (or less), clipped to wire insulation or "gimmick".	10.7 MC	None	—	Z4, bottom	Maximum indication on tuning indicator
3	Point of no signal and no interference	FM generator connected to TEST POINT 1 through 0.5 pF (or less), clipped to wire insulation or "gimmick".	10.7 MC	None	Connect DC VTVM across C47	Z5 top and bottom for maximum indication	Between 15 and 20 volts
4	Point of no signal and no interference	FM generator connected to TEST POINT 1 through 0.5 pF (or less), clipped to wire insulation or "gimmick".	10.7 MC	None	Connect DC VTVM to TEST POINT 4	Z5, top,	Zero volts — between negative and positive swing
5	90 MC	FM generator connected to 300 ohm terminals through 120 ohm carbon resistors	90 MC	30% FM (22.5 KC Dev.) at 400 cps.	DC VTVM to test point 2 and scope to RIGHT or LEFT OUTPUT jack	L6, L4 and L3 for maximum negative voltage	Less than —4 volts
6	106 MC	FM generator connected to 300 ohm terminals through 120 ohm carbon resistors	106 MC	30% FM (22.5 KC Dev.) at 400 cps.	DC VTVM to test point 2 and scope to RIGHT or LEFT OUTPUT jack	C14, C12 and C10 for maximum negative voltage	Less than —4 volts
7	98 MC	FM generator connected to 300 ohm terminals through 120 ohm carbon resistors	98 MC	30% FM (22.5 KC Dev.) at 400 cps.	DC VTVM to test point 2 and scope to RIGHT or LEFT OUTPUT jack	L1 for maximum negative voltage	Less than —4 volts
8	Repeat steps 5, 6 and 7 for proper dial calibration and maximum output.						

# P1136 PARTS DESCRIPTION LIST • TUNER

P1136

## CAPACITORS

10% Tolerance for all fixed capacitors, unless otherwise noted or marked GMV (guaranteed minimum value). All capacitors not marked uF are pF (uF).

Symbol	Description	Part No.
C1	Ceramic, 33, N750, 1000V	C50070-15
C2	Ceramic, 47, 5%, N750, 1000V	C50070-29
C3	Ceramic, 1, 20%, P100, 1000V	C50070-1
C4	Ceramic, 1000 GMV, 500V	C50089-2
C5, 6, 7	Ceramic, Feedthru, 1000, GMV	C592-187
C8	Ceramic, 1000, GMV, 500V	C50089-2
C9	Ceramic, 7, ±.5pF, NPO, 500V	CC20CJ070D5
C10	Ceramic, Trimmer	C662-123
C11A-J	Variable, FM-AM Tuning	C965-123
C12	Ceramic, Trimmer	C662-123
C13	Ceramic, 8, ±.5pF NPO, 500V	CC20CJ080D5
C14	Ceramic, Trimmer	C662-123
C15	Ceramic, 8, ±.5pF N330, 500V	CC20SJ080D5
C16	Ceramic, 6, 5%, NPO, 1000V	C50070-43
C17	Ceramic, 68, N750, 500V	CC20UJ680K5
C18, 19	Ceramic, 100, N1500, 1000V	C50070-6
C20	Ceramic, Feedthru, 1000, GMV	C592-187
C21	Ceramic, 24, 5%, N150, 1000V	C50070-8
C22	Ceramic, 100, 5%, N1500, 1000V	C50070-19
C23	Ceramic, Feedthru, 1000, GMV	C592-187
C24	Ceramic, .02uF, +80-20%, 500V	C50089-4
C25	Ceramic, 5000, +80-20%, 500V	C50089-6
C26	Ceramic, 2700, 1000V	C50072-17
C27	Ceramic, 20%, P100, 1000V	C50070-1
C28	Ceramic, 330, 1000V	C50072-1
C29	Mylar, .022uF, 100V	C50574-7
C30	Ceramic, 500, +80-20%, 500V	C50089-6
C31	Ceramic, 2700, 1000V	C50072-17
C32	Ceramic, 5000, +80-20%, 500V	C50089-6
C33	Ceramic, 24, 5%, N150, 1000V	C50070-8
C34	Ceramic, 5000, +80-20%, 500V	C50089-6
C35	Ceramic, 2700, 1000V	C50072-17
C36	Ceramic, 18, 10%, N470, 1000V	C50070-13
C37	Ceramic, 5000, 20%, 500V	C50089-1
C38	Ceramic, 1000, GMV, 500V	C50089-2
C39	Ceramic, .02uF, +80-20%, 500V	C50089-4
C40	Ceramic, .1uF, 20%, 250V	C50633-1
C41	Ceramic, 2700, 1000V	C50072-17
C42, 43	Ceramic, 5000, +80-20%, 500V	C50089-6
C44	Ceramic, .02uF, GMV, 1000V	C50071-6
C45, 46	Ceramic, 330, 1000V	C50072-1
C47	Electrolytic, 8uF, 50V	C629-138
C48	Ceramic, .02uF, +80-20%, 500V	C50089-4
C49	Ceramic, 100, 10%, N1500, 1000V	C50070-6
C50	Ceramic, 100, GMV, N1500, 1000V	C50070-5
C51, 52		
53, 54	Ceramic, .02uF, +80-20%, 500V	C50089-4
C55, 56		
57, 58		
59, 60, 61	Ceramic, 5000pF, +80-20%, 500V	C50089-6
C62	Ceramic, Feedthru, 1000, GMV	C592-187
C63	Ceramic, 5000pF, +80-20%, 500V	C50089-6
C64	Electrolytic, 4-Section A-20uF, 300V B-40uF, 350V C-60uF, 200V D-60uF, 200V	
C68, 69	Ceramic, 100, GMV, N1500, 1000V	C50070-5
C70, 71	Mylar, .022uF, 400V	C50574-8
C72, 73	Ceramic, .01uF, 20%, 500V	C50089-3
C74, 75	Ceramic, 24, 5%, N150, 1000V	C50070-8

C76, 77	Ceramic, 1500, 1000V	C50072-10
C78, 79	Mylar, .015, 400V	C50574-12
C80, 81	Ceramic, .01uF, 20%, 500V	C50089-3
C82, 83	Ceramic, 100, N1500, 1000V	C50070-6
C84, 85	Mylar, .047, 400V	C50197-30
C86, 87	Ceramic, 470, 1000V	C50072-13
C88	Ceramic, 1000, 1000V	C50072-3
C89	Mylar, .022uF, 100V	C50574-7
C90	Ceramic, .68, 500V	C50077-6N

## RESISTORS AND POTENTIOMETERS

Deposited carbon, in ohms, 5% Tolerance, 1/8 watt unless otherwise noted. K=Kilohm, M=Megohm.

Symbol	Description	Part No.
R1	Composition, 100K, 10%, 1/2W	RC20BF104K
R2	47	R12DC470J
R3	100K	R12DC104J
R4	470K	R12DC474J
R5	2.7K	R12DC272J
R6, 7	Composition, 1K, 10%, 1/2W	RC20BF102K
R8	Composition, 180, 10%, 1/2W	RC20BF180K
R9	39K	R12DC393J
R10	3.3M, 5%, 1/3W	R33DC335J
R11	Composition, 27K, 10%, 1/2W	RC20BF273K
R12	Composition, 1K, 10%, 1/2W	RC20BF102K
R13, 14	39K	R12DC393J
R15	Composition, 47K, 10%, 1/2W	RC20BF473K
R16	Composition, 150, 10%, 1/2W	RC20BF150K
R17	Composition, 1K, 10%, 1/2W	RC20BF102K
R18	2.2M, 5%, 1/3W	R33DC225J
R19	68K	R12DC683J
R20	15K	R12DC153J
R21	Composition, 82K, 10%, 1/2W	RC20BF823K
R22	Composition, 1K, 10%, 1/2W	RC20BF102K
R23	1M	R12DC105J
R24	100K	R12DC104J
R25	Potentiometer, Muting Level 100K	R50103-8
R26	3.3M, 5%, 1/3W	R33DC335J
R27	1M	R12DC105J
R28	2.2M, 5%, 1/3W	R33DC225J
R29, 30	47K	R12DC473J
R31	Composition, 68K, 10%, 1/2W	RC20BF683K
R32	Composition, 1K, 10%, 1/2W	RC20BF102K
R33	1M	R12DC105J
R34	270	R12DC271J
R35	1.5K	R12DC152J
R36	6.8K	R12DC682J
R37	1K	R12DC102J
R38	6.8K	R12DC682J
R39	470K	R12DC474J
R40	2.2M, 5%, 1/3W	R33DC225J
R41	120K	R12DC124J
R42	1M	R12DC105J
R43	100	R12DC101J
R44	Composition, 47K, 10%, 1/2W	RC20BF473K
R45	22K	R12DC223J
R46	Composition, 18K, 10%, 1W	RC30BF183K
R47, 48	270	R12DC271J
R49	1.8M, 5%, 1/3W	R33DC185J
R50	Composition, 39, 10%, 1/2W	RC20BF390K
R51, 52	Wirewound, 150, 10%, 3W	RPG3W151K
R53	Composition, 22K, 10%, 1/2W	RC20BF223K
R54	820K	R12DC824J
R55, 56	Wirewound, 330, 5%, 2W	RW200W331J
R57, 58	10K	R12DC103J
R59, 60	47K	R12DC473J

R61, 62	10	R12DC100J
R63, 64	Glass, 330K, 5%, 1W	R30G334J
R65, 66	220K, 5%, 1/3W	R33DC334J
R67, 68	4.7M, 5%, 1/3W	R33DC475J
R69, 70	220K	R12DC224J
R71, 72	47K	R12DC473J
R73, 74	470K	R12DC474J
R75, 76	2.7M, 5%, 1/3W	R33DC275J
R77, 78	1.5M, 5%, 1/3W	R33DC105J
R79, 80	100K, 5%, 1/3W	R33DC104J
R81, 82	1K	R12DC102K
R83, 84	680K	R12DC684J
R85A, B	Potentiometer, Dual 500K Treble	R50160-165-1
R86, A, B	Potentiometer, Dual 500K Bass	R50160-165-2
R87, 88	-Deleted-	
R89, 90	47K	R12DC473J
R91, 92	220K	R12DC224J
R93, 94	100K, 5%, 1/3W	R33DC104J
R95, 96	1K	R12DC102J
R97, 98	47K, 5%, 1/3W	R33DC473J
R99, 100	22K	R12DC223J
R101A, B	Potentiometer, Dual 500K, Volume	R50160-166
R102	-Deleted-	
R103, 104	2.7M, 5%, 1/3W	R33DC275J
R105	Potentiometer, 500K, Balance	R50160-167
R106, 107	Glass, 2.7K, 5%, 1/2W	R30G272J
R108	330K	R12DC334J
R109	Composition, 2.7K, 10%, 1/2W	RC20BF272K
R110, 111		
112, 113	Composition, 120K, 10%, 1/2W	RC20BF124K

#### MISCELLANEOUS

Symbol	Description	Part No.
CR1	Diode, 1N38	V1N38
CR2	Diode, AA113	V50260-22
I1, 2	Lamp, Dial	I50441-5
I3	Lamp, Cabinet	I50009-7
I4	Lamp, Stereo Beacon	850461-3
L1	Coil, FM Antenna	L965-119
L2	Coil, AM Ferrite Loop Antenna	L50695
L3	Coil, FM RF	L965-116
L4	Coil, FM Mixer	L965-117
L5	Choke, 1.5 Microhenries	L50066-4
L6	Coil Assembly, FM Oscillator	AS965-120
L7, 8, 9	Choke, 1 Microhenry	L50066-2
L10	Choke, 2.2 Microhenry	L50066-6
L11, 12	Choke, 1 Microhenry	L50066-2
L13	AM-RF Transformer	L50210-35
L14	Coil, AM Oscillator	L50210-28
PC1	Printed Circuit	PC50434A
PC2, 3	Printed Circuit Phono Equalization	PC50187-12
PC4, 5	Printed Circuit, Tone	PC50187-9
PC6, 7	Printed Circuit, High Filter	PC50187-2
Q1	Transistor 2925	TR2925
PS1	Switch, Pushbutton, Mode Selector	S1136-118
PS2	Switch, Pushbutton, Input Selector	S1136-119
S3	Switch, Power	R101
S4	Switch, Auto Shut-Off	S50358-6
S5	Switch, Speakers	S946-216-1
S6	Switch, Muting	S1136-130
Z1	Transformer, FM IF	ZZ20510-42
Z2	Transformer, AM IF	ZZ2987
Z3	Transformer, FM IF	ZZ629-142
Z4	Coil, FM Limiter	ZZ50210-61
Z5	Transformer, FM Ratio Detector	ZZ50210-9
Z6	Transformer, AM IF	ZZ50210-40

# P1136 SCHEMATIC DIAGRAM • TUNER

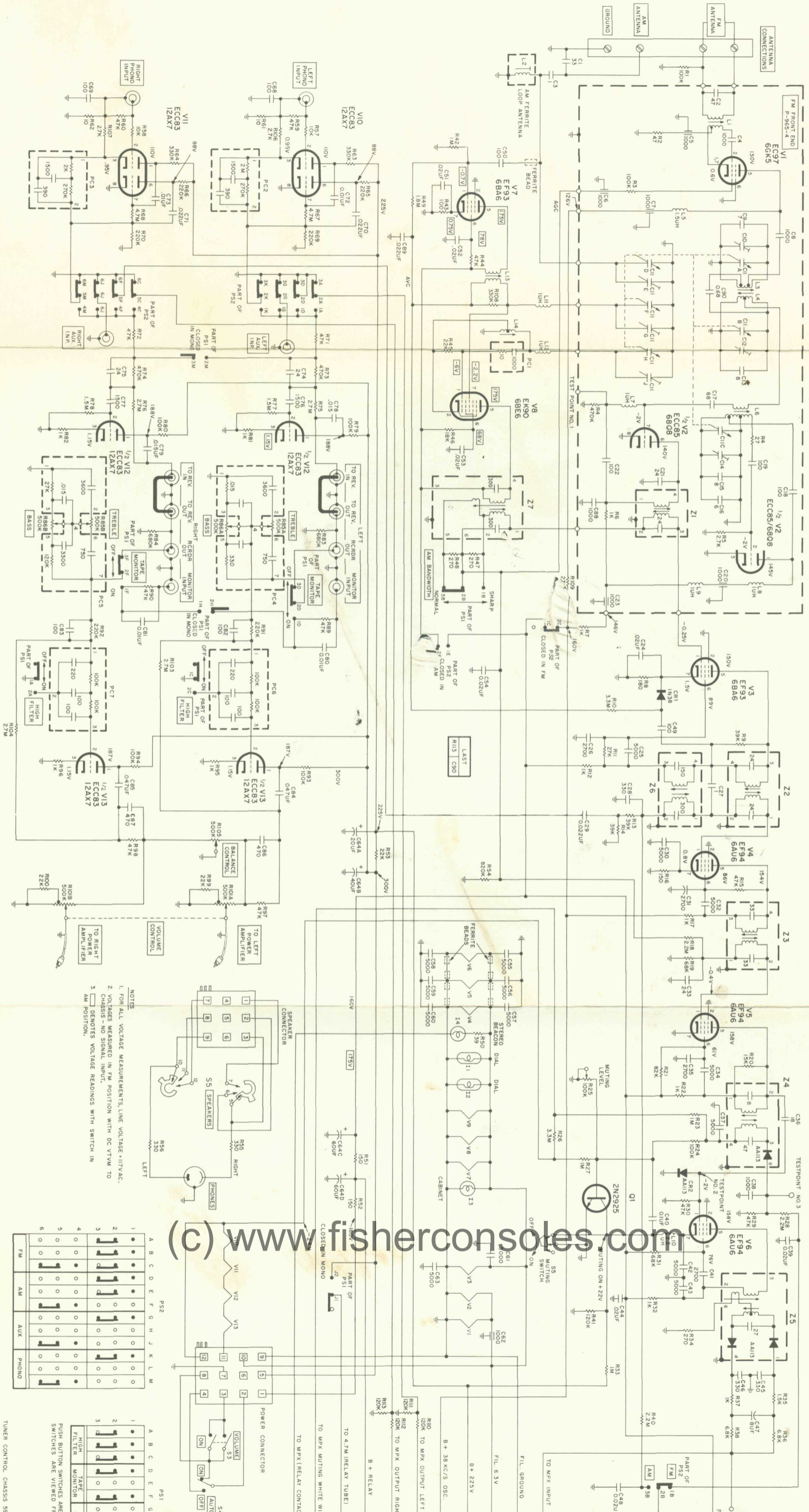

- NOTES**
1. FOR ALL VOLTAGE MEASUREMENTS, LINE VOLTAGE = 117VAC.
  2. VOLTAGES MEASURED IN FM POSITION WITH DC VTVM TO CHASSIS - NO SIGNAL INPUT.
  3. DENOTES VOLTAGE READINGS WITH SWITCH IN AM POSITION.

	A	B	C	D	E	F	G	H	J	K	L	M
FM	•	•	•	•	•	•	•	•	•	•	•	•
AM	•	•	•	•	•	•	•	•	•	•	•	•
AUX	•	•	•	•	•	•	•	•	•	•	•	•
PHONO	•	•	•	•	•	•	•	•	•	•	•	•

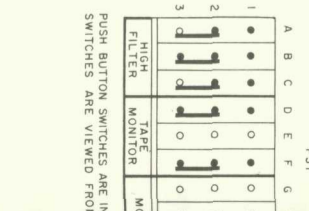

# 1136 SCHEMATIC DIAGRAM • TUNER

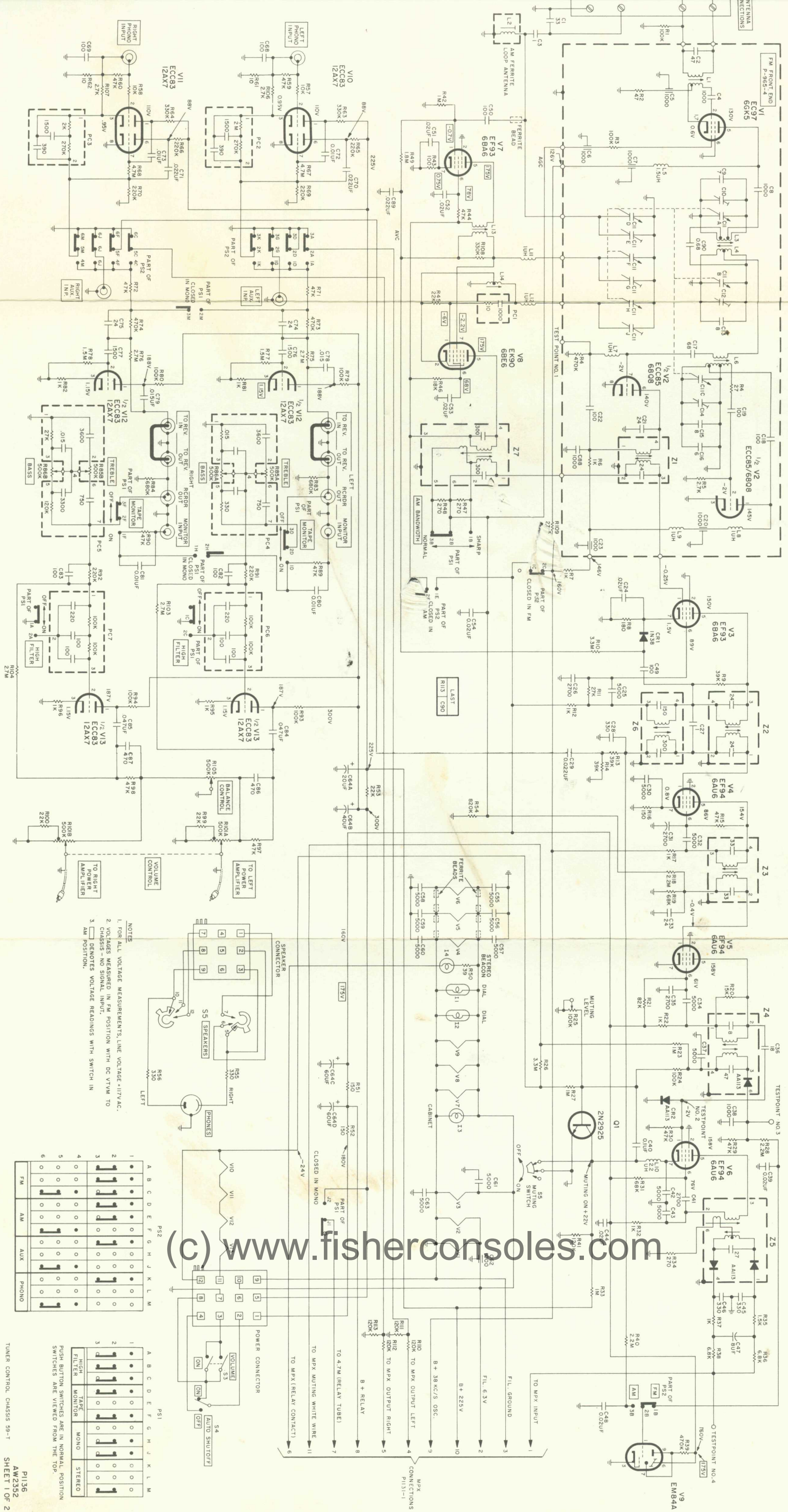

- NOTES**
- FOR ALL VOLTAGE MEASUREMENTS, LINE VOLTAGE = 117VAC.
  - VOLTAGES MEASURED IN FM POSITION WITH DC VTVM TO CHASSIS - NO SIGNAL INPUT.
  - DEMOTES VOLTAGE READINGS WITH SWITCH IN AM POSITION.

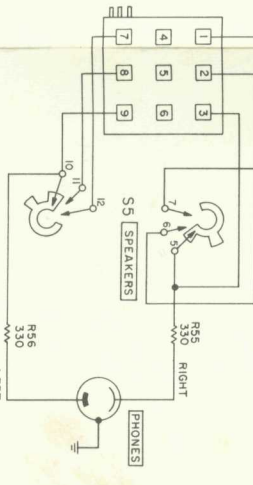

	A	B	C	D	E	F	G	H	I	J	K	L	M
FM	•	•	•	•	•	•	•	•	•	•	•	•	•
AM	•	•	•	•	•	•	•	•	•	•	•	•	•
AUX	•	•	•	•	•	•	•	•	•	•	•	•	•
PHONO	•	•	•	•	•	•	•	•	•	•	•	•	•

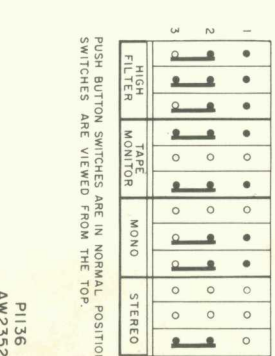

# REAR VIEW CONSOLE CONNECTIONS

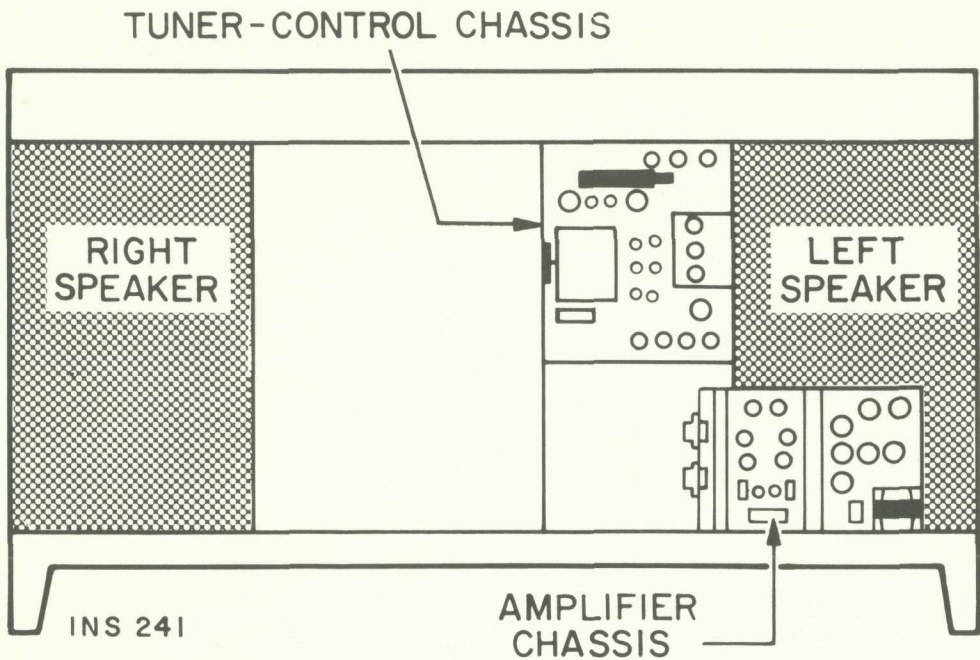

## 110 SCHEMATIC DIAGRAM • SPEAKER SYSTEMS

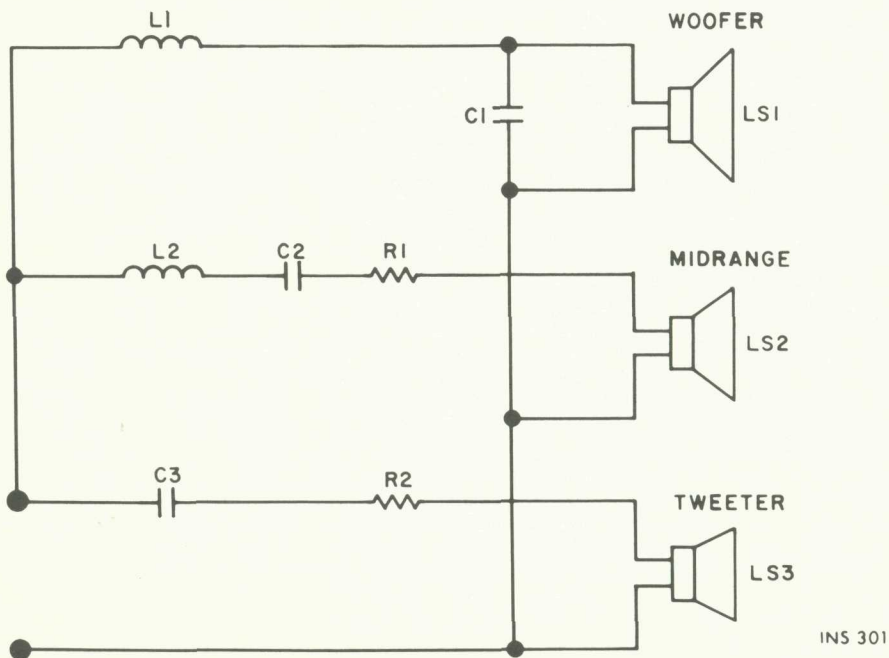

### PARTS DESCRIPTION LIST

Symbol	Description	Part No.			
C1	Capacitor, 100uF, non-polarized	C3100	LS1	Woofer, 12-inch	W141
C2	Capacitor, 18uF, non-polarized	C318	LS2	Mid-range, 5-inch	M135
C3	Capacitor, 2uF, nonpolarized	C302	LS3	Tweeter, 2½-inch	T129A
L1	Inductor	L211.5	R1	Resistor, 5.6-ohms	R405.6
L2	Inductor	L216	R2	Resistor, 4.7-ohms	R404.7



# SCHEMATIC DIAGRAM • MULTIPLEX SECTION

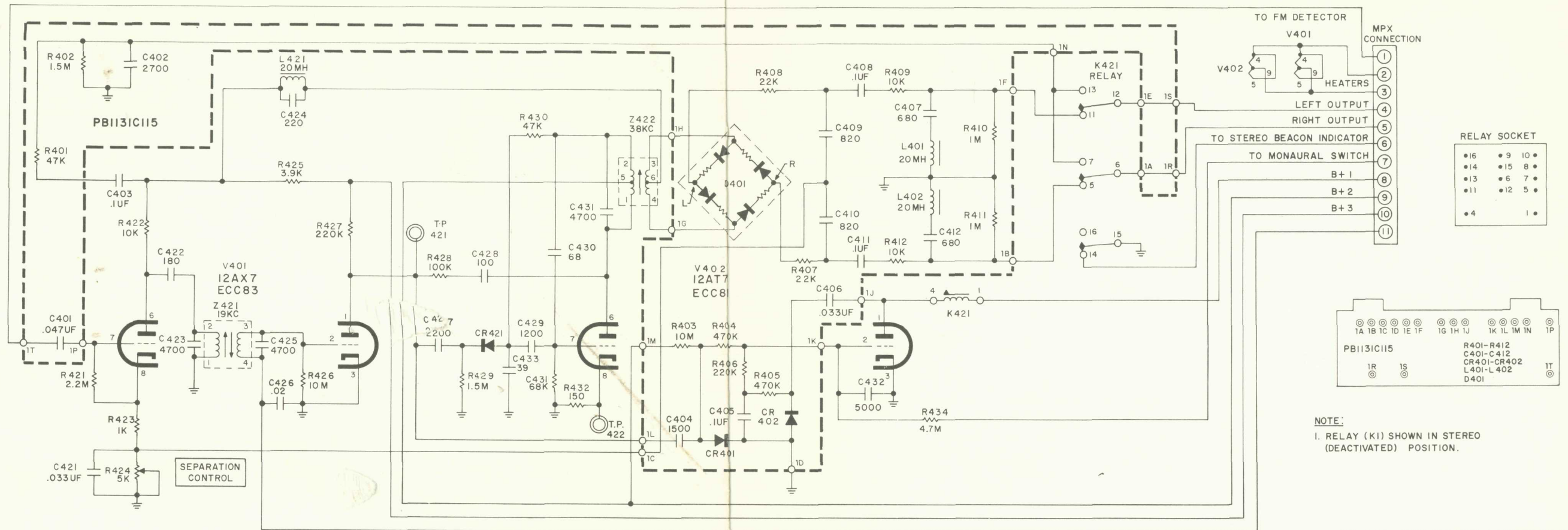

**NOTE:**  
I. RELAY (KI) SHOWN IN STEREO (DEACTIVATED) POSITION.

AW2256C MPX-125 P1131-I SCHEMATIC

# PARTS DESCRIPTION LIST • MULTIPLEX SECTION

## MULTIPLEX SECTION

All circuit components with symbols beginning with 401 are located on the printed-circuit board; those beginning with 421 are mounted on the metal subchassis.

### CAPACITORS

20% tolerance for all fixed capacitors, unless otherwise noted or marked GMV (guaranteed minimum value). All capacitors not marked uF are pF (uuf).

Symbol	Description	Part No.
C401	Capacitor, Mylar, .047uF 10% 100V	C50B574-5
C402	Capacitor, Polystyrene, 2700 5% 125V	C50B634-20
C403	Capacitor, Plastic Film, .1uF 20% 250V	C50B633-1
C404	Capacitor, Cer. Disc., 1500, 10%	C50B576-4
C405	Capacitor, Plastic Film, 1uF 20% 250V	C50B633-1
C406	Capacitor, Plastic Film, .033uF 20% 400V	C50B633-20
C407	Capacitor, Cer. Disc, 470 pF 10%	C50B576-1
C408	Capacitor, Plastic Film, .1uF 20% 250V	C50B633-1
C409	Capacitor, Cer. Disc, 820 10%	C50B576-3
C410	Capacitor, Cer. Disc, 820 10%	C50B576-3
C411	Capacitor, Plastic Film, .1uF 20% 250V	C50B633-1

Symbol	Description	Part No.
C412	Capacitor, Cer. Disc, 470 pF, 10%	C50B576-1
C421	Mylar, .033 uF, 10%, 100V	C50574-11
C422	Polystyrene 180, 5%, 500V	C50634-1
C423	Polystyrene 4700, 5%, 125V	C50634-21
C424	Polystyrene 220, 5%, 500V	C50634-2
C425	Polystyrene 4700, 5%, 125V	C50634-21
C426	Ceramic, .02uF, 20%, 500V	C50089-5
C427	Ceramic, 2200, 20%, 1000V	C50183-10
C428	Ceramic, 100, 20%, 1000V	C50183-9
C429	Ceramic, 1200, 10%, 1000V	C50183-8
C430	Ceramic, 68, 10%, NPO, 1000V	C50070-46
C431	Mica, 4700, 5%, 300V	C50332-7
C432	Ceramic, 5000, 20%, 500V	C50089-1
C433	Ceramic, 39, 10%, N1500, 1000V	C50070-17

### RESISTORS

Symbol	Description	Part No.
R401	Resistor, Dep. Carbon, 47K, 5% 1/8W	R12DC473J
R402	Resistor, Dep. Carbon, 1.5M, 5% 1/3W	R33DC155J
R403	Resistor, Composition, 22M, 10%, 1/2W	RC20BF226K
R404	Resistor, Dep. Carbon, 470K, 5%, 1/8W	R12DC474J

Symbol	Description	Part No.
R405	Resistor, Dep. Carbon, 470K, 5%, 1/8W	R12DC474J
R406	Resistor, Dep. Carbon, 470K, 5%, 1/8W	R12DC224J
R407	Resistor, Dep. Carbon, 22K, 5%, 1/8W	R12DC223J
R408	Resistor, Dep. Carbon, 22K, 5%, 1/8W	R12DC223J
R409	Resistor, Dep. Carbon, 10K, 5%, 1/8W	R12DC103J
R410	Resistor, Dep. Carbon, 1K, 5%, 1/8W	R12DC105J
R411	Resistor, Dep. Carbon, 1M, 5%, 1/8W	R12DC105J
R412	Resistor, Dep. Carbon, 10K, 5%, 1/8W	R12DC103J

### RESISTORS

Symbol	Description	Part No.
R421	Dep. Carbon, 2.2M, 5%, 1/3W	R33DC225J
R422	Dep. Carbon, 10K, 5%, 1/3W	R33DC103J
R423	Dep. Carbon, 1K, 5%, 1/3W	R33DC102J
R424	Potentiometer, 5K, MPX Separation	R50150-11
R425	Dep. Carbon, 3.9K, 5%, 1/3W	R33DC392J
R426	Composition, 10M, 10%, 1/2W	RC20BF106K
R427	Dep. Carbon, 220K, 5%, 1/3W	R33DC224J

Symbol	Description	Part No.
R428	Dep. Carbon, 100K, 5%, 1/8W	R12DC104J
R429	Dep. Carbon, 1.5M, 5%, 1/3W	R33DC155J
R430	Dep. Carbon, 47K, 5%, 1/3W	R33DC473J
R431	Dep. Carbon, 68K, 5%, 1/8W	R12DC683J
R432	Dep. Carbon, 150, 5%, 1/3W	R33DC151J
R433	-Deleted-	
R434	Composition, 4.7M, 10%, 1/2W	RC20BF475K

### MISCELLANEOUS

Symbol	Description	Part No.
CR401	Diode	V1112
CR402	Diode	V50A260-15
CR421	Diode, Type 1112	V1112
D401	Ring Demodulator	V50A260-18
K421	Relay	K50603
L401	Coil	L50334-2
L402	Coil	L50334-2
L421	Coil, 20 uH	L50334-2
Z421	Transformer, 19Kc	ZZ50210-34
Z422	Transformer, 38Kc	ZZ50210-54
	Relay Socket	X50602-2
	Printed Circuit Bd.	PB1131B111
	Mini, Pin Term.	A50A577
	Sleeving 23-32" Lg.	E50A684-4

# P1131-1 MULTIPLEX DECODER

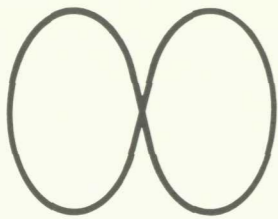

FIGURE 1. Lissajous pattern for MPX Oscillator alignment.

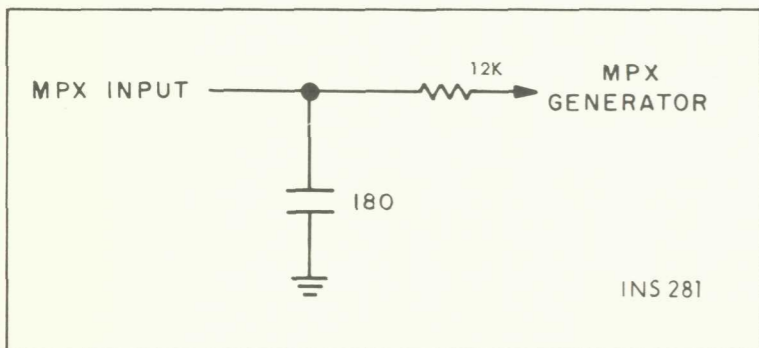
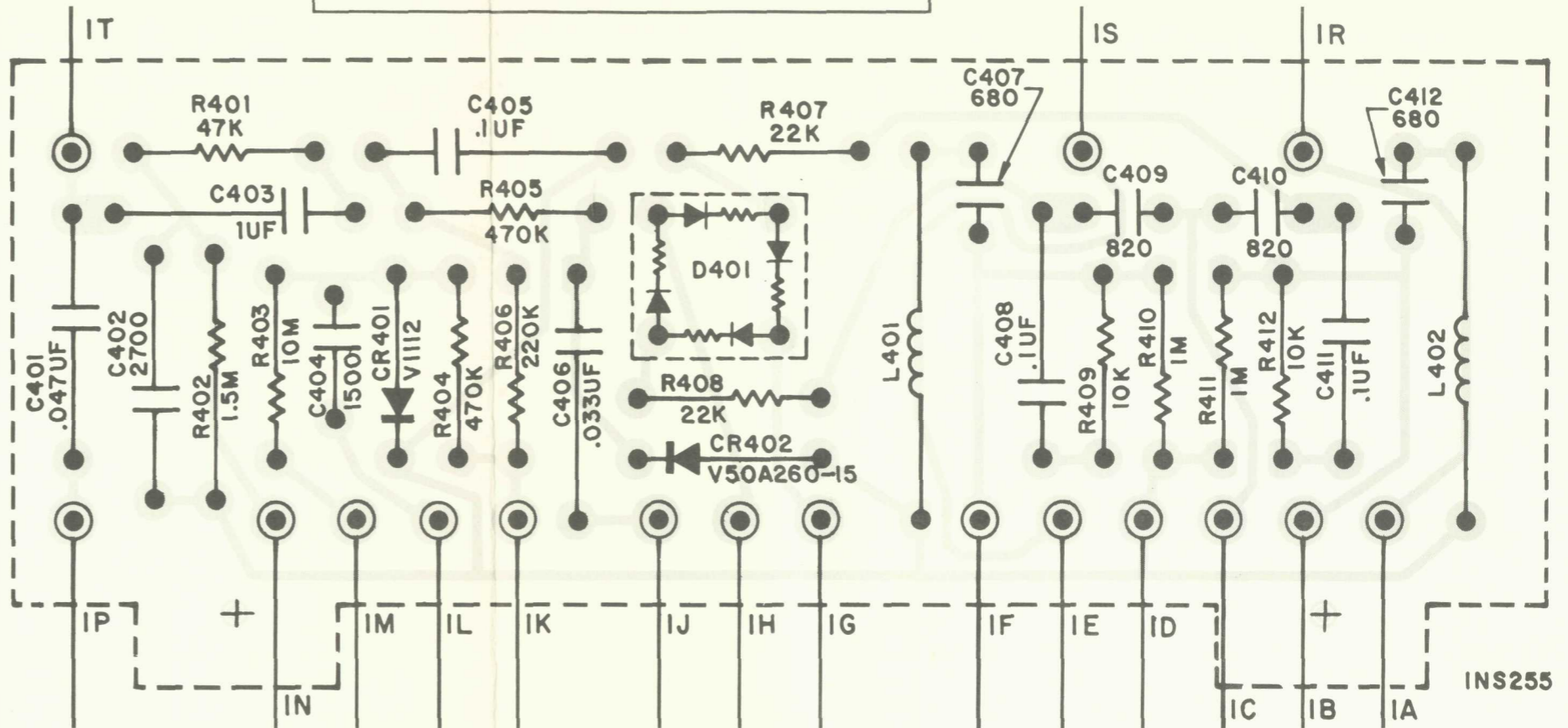

FIGURE 2. Multiplex-alignment coupling network circuit.



## ALIGNMENT INSTRUCTIONS • MULTIPLEX SECTION

### GENERAL

The preferred alignment procedure, in table 1 below, uses a multiplex generator with an RF output, like the FISHER Model 300. Optimum performance will be obtained only when the multiplex decoder is connected to the FM detector with which it will be used. Check IF alignment first—poor alignment can prevent proper multiplex decoder operation.

**TEST EQUIPMENT REQUIRED:** MULTIPLEX GENERATOR, AUDIO (AC) VTVM, 100 KC OSCILLOSCOPE WITH EXTERNAL SWEEP JACKS, ALIGNMENT TOOL.

TABLE 1

STEPS	GENERATOR		R F DEVIATION	INDICATOR TYPE AND CONNECTION	ALIGNMENT	
	CONNECTION	MODULATION			ADJUST	INDICATION
1	Multiplex generator RF output to antenna terminals	19 kc pilot only	±7.5 kc	VTVM to TP 1	Z1 top and bottom	Maximum reading on VTVM
2	19 kc output of generator to oscilloscope horizontal input; generator not connected to MPX section	—	—	Vertical input of oscilloscope to TP 2; set oscilloscope for external sweep	Z2	Set frequency of free-running oscillator as close as possible to 38 kc. Lissajous pattern (see figure 1) should be as slow-moving as possible.
3	Same as Step 1	Composite MPX; 1000 cps on left channel only	±75 kc	VTVM and oscilloscope vertical input to right channel output lug (terminal 1R)	Z1 top	Maximum reading on VTVM; clean 1000 cps sine wave on oscilloscope
4	Same as Step 1	Composite MPX; 1000 cps on right channel only	±75 kc	Same as Step 3	MPX separation control (R4)*	Minimum reading on VTVM should be at least 33 db below reading obtained in Step 3
5	Same as Step 1	Same as Step 4	±75 kc	VTVM and oscilloscope vertical input to right channel output lug (terminal 1S)	—	Same VTVM reading as obtained in Step 3 ± 2 db; clean 1000 cps sine wave on oscilloscope
6	Same as Step 1	Composite MPX; 1000 cps on left channel only	±75 kc	Same as Step 5	MPX separation control (R4), if necessary*	Minimum reading on VTVM should be at least 33 db below reading obtained in Step 5.

\* If adjustment is required, adjust for best compromise readings in Steps 4 and 6.

### ALTERNATE ALIGNMENT PROCEDURE For multiplex generators without an RF output

When using this alignment procedure, it is necessary to disconnect the ratio detector from the multiplex decoder at the point where the generator is connected. Unsolder point IT carefully. The generator input must be through a simple low-pass filter—a 12 K resistor between the multiplex generator and the MPX input with a 180 pF capacitor from the MPX input end of the resistor to ground (Figure 2).

**TEST EQUIPMENT REQUIRED:** MULTIPLEX GENERATOR, AUDIO (AC) VTVM, 100 KC OSCILLOSCOPE WITH EXTERNAL SWEEP JACKS, ALIGNMENT TOOL.

TABLE 2

STEPS	GENERATOR			INDICATOR TYPE AND CONNECTION	ALIGNMENT	
	CONNECTION	AUDIO	LEVEL		ADJUST	INDICATION
1	Composite output of MPX generator to input of MPX demodulator (Point 1)	19 kc pilot only	100 mV RMS (280 MV P-P)	AC VTVM to TP 1	Z1 top and bottom	Maximum reading on VTVM
2	19 kc output of generator to oscilloscope horizontal input; generator not connected to MPX section	—	—	Oscilloscope vertical input to TP 2	Z2	Set frequency of free-running oscillator as close as possible to 38 kc. Lissajous pattern (see figure 1) should be as slow-moving as possible.
3	Same as Step 1	1000 cps on left channel only	0.7 V RMS (3.92 V P-P)	AC VTVM and oscilloscope vertical input to left channel output lug (terminal 1R)	Z1 top	Maximum reading on VTVM; clean 1000 cps sine wave on oscilloscope
4	Same as Step 1	1000 cps on right channel only	0.7 V RMS (3.92 V P-P)	Same as Step 3	MPX separation control (R4)*	Minimum reading on VTVM should be at least 33 db below reading obtained in Step 3
5	Same as Step 1	Same as Step 4	0.7 V RMS (3.92 V P-P)	VTVM and oscilloscope vertical input to right channel output lug (terminal 1S)	—	Same VTVM reading as obtained in Step 3 ± 2 db; clean 1000 cps sine wave on oscilloscope
6	Same as Step 1	1000 cps on left channel only	0.7 V RMS (3.92 V P-P)	Same as Step 5	MPX separation control (R4), if necessary*	Minimum reading on VTVM should be at least 33 db below reading obtained in Step 5.

\* If adjustment is required, adjust for best compromise readings in Steps 4 and 6.

## DIAL STRINGING PROCEDURE

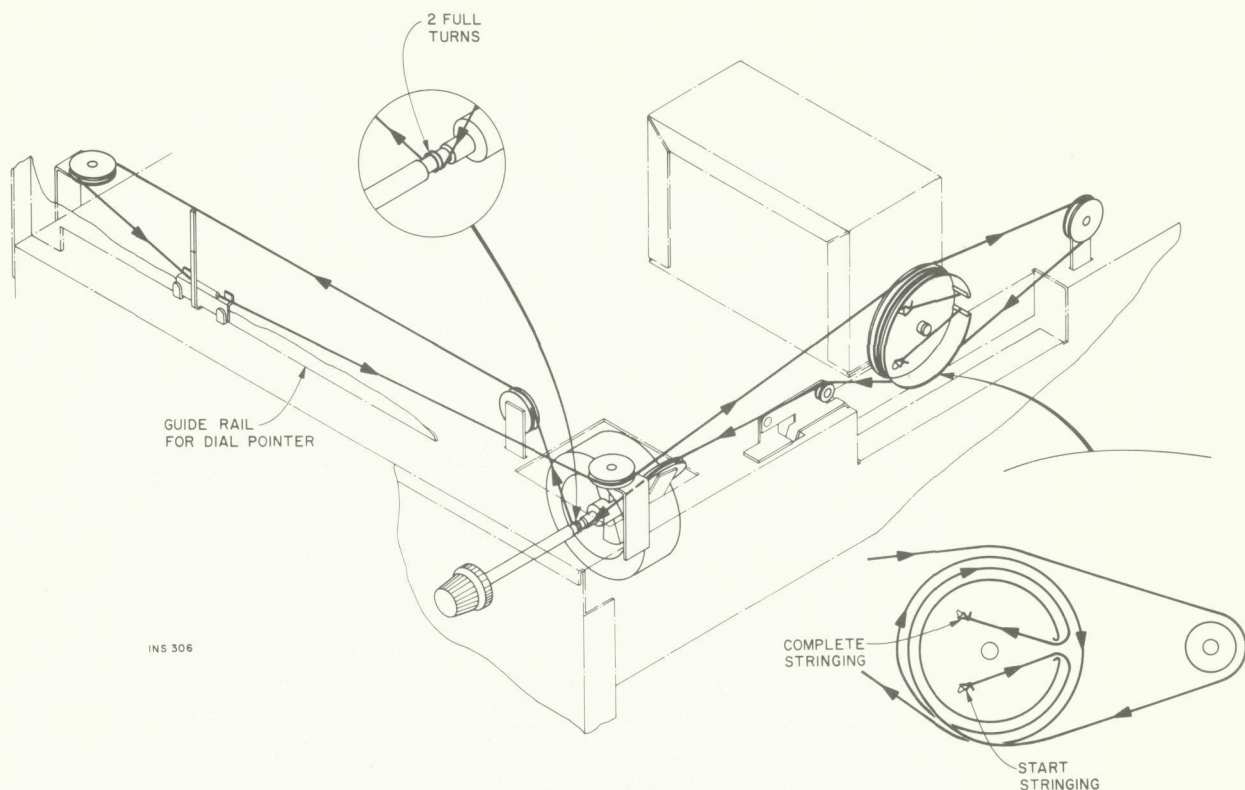

INS 306

- 1 – Rotate variable-capacitor drive-drum to its maximum clockwise position.
- 2 – Fasten dial cord to drum. Wind dial cord clockwise around drum as shown in detail drawing. Keep dial cord taut while stringing to prevent slippage when stringing is completed.
- 3 – After stringing is completed rotate tuning drive to extreme counterclockwise position and set dial pointer to zero on the logging scale. Then cement pointer to dial cord.

If replacement parts are out of stock, locally, they may be obtained directly from the Parts Department of FISHER Radio Corporation. They will be shipped "best way", either prepaid or C.O.D. unless otherwise specified.

For instrument-operation information and technical assistance write Richard Hamilton, Customer Service Department, FISHER Radio Corporation, Long Island City, New York 11101.

# P1198 PARTS DESCRIPTION LIST • AMPLIFIER

## CAPACITORS

Symbol	Description	Part No.
C1, 2	Mylar, 022uF, 10%, 250V	C50197-49
C3, 4	Electrolytic, 100uF, 15V	C50483-5
C5, 6	Ceramic, 24pF, 5%, N150, 1000V	C50070-8
C7, 8	Electrolytic, 20uF, 250V	C50475-3
C9, 10	Electrolytic, 16uF, 10V	C50483-10
C11, 12		
13, 14	Electrolytic, 100uF, 25V	C50483-6
C15, 16	Ceramic, 1000pF, 10%, 1000V	C50072-3
C17, 18	Ceramic, 330pF, 10%, 1000V	C50072-1
C19	Electrolytic, 4uF, 350V	C50475-4
C20	Electrolytic 4 Section	C50180-63
	A-40uF, 400V	
	B-40uF, 400V	
	C-40uF, 400V	
	D-60uF, 200V	
C21, 22	Electrolytic, 200uF, 35V	C50483-7
C23	Electrolytic, 3000uF, 35V	C50180-61DX
C24	Mylar, .01uF, 10%, 250V	C50197-48
C25	Electrolytic, 100uF, 200V	C50475-2
C26, 27	Molded, .01uF, 20%, 600V	C2747
C28	Electrolytic, 3000uF, 35V	C50180-61DX
C29	Electrolytic, 100uF, 200V	C50475-2
C30, 31	Ceramic, 16pF, 10%, N75, 1000V	C50070-21
C32, 33	Mylar, .33uF, 20%, 250V	C50575-6

R26	Wirewound, 100, 5%, 2W	RW200W101J
R27	Wirewound, 220, 5%, 2W	RW200W221J
R28	Wirewound, 270, 5%, 2W	RW200W271J
R29	Wirewound, 100, 5%, 2W	RW200W101J
R30	Wirewound, 220, 5%, 2W	RW200W221J
R31, 32		
33, 34	Wirewound, 1 ohm, 5%, 3W	RL300W010J
R35, 36	2.7K	R12DC272J
R37A, B	Wirewound, 15 + 10, 10%, 10W	R50500-2BX
R38	-Deleted-	
R39A, B	Wirewound, 15 + 10, 10%, 10W	R50500-2BX
R40	-Deleted-	
R41	Composition, 820, 10%, 1/2W	RC20BF821K
R42	Composition, 1K, 10%, 1/2W	RC20BF102K
R43	100K	R12DC104J
R44	Wirewound, 390, 10%, 3W	RPG3W391K
R45, 46	Glass, 70, 5%, 3W	RPG3W700J
R47	100K	R12DC104J
R48, 49	Glass, 370, 5%, 3W	RPG3W391K
R50	Wirewound, 150, 10%, 3W	RPG3W151K
R51	Wirewound, 1 ohm, 5%, 3W	RL300W010J
R52	Composition, 820, 10%, 1/2W	RC20BF821K
R53, 54	47K	R12DC473J
R55, 56		
57, 58	Composition, 22, 10%, 1/2W	RC20BF220K
P1, 2, 3, 4	Potentiometer, 10, 20%, 2W	R50160-141-1

## RESISTORS AND POTENTIOMETERS

Deposited carbon, in ohms, 5% Tolerance, 1/8 watt unless otherwise noted. K=Kilohm, M=Megohm.

Symbol	Description	Part No.
R1, 2	1M	R12DC105J
R3	220K, 5%, 1/3W	R33DC224J
R4	1.8K	R12DC182J
R5	82	R12DC820J
R6	220K, 5%, 1/3W	R33DC224J
R7	1.8K	R12DC182J
R8	82	R12DC820J
R9, 10	22K	R12DC223J
R11, 12	1K	R12DC102J
R13, 14	Wirewound 6.8K, 10%, 7W	RPG7W682K
R15, 16	1.8K	R12DC182J
R17, 18	10K	R12DC103J
R19	Wirewound, 270, 5%, 2W	RW200W271J
R20	Wirewound, 100, 5%, 2W	RW200W101J
R21	Wirewound, 220, 5%, 2W	RW200W221J
R22	Wirewound, 270, 5%, 2W	RW200W271J
R23	Wirewound, 100, 5%, 2W	RW200W101J
R24	Wirewound, 220, 5%, 2W	RW200W221J
R25	Wirewound, 270, 5%, 2W	RW200W271J

## MISCELLANEOUS

Symbol	Description	Part No.
F1, 2, 3, 4	Fuse 2A	F755-145
F5	Fuse 3.2A Slo-Blo	F3319
CR1, 2	Silicon, Diode	SR50411-1
CR3, 4, 5, 6	Silicon Rectifier	SR50517
Q1, 3, 5, 7	Transistor, 35524	TR35524
Q2, 4, 6, 8	Transistor, 35144	TR35144
T1	Transformer, Driver (Left)	T1068-116-1
T2	Transformer, Driver (Right)	T1068-116-2
T3	Transformer, Power	T1198-115
	Dial Glass, Screened	N1136-107
	Knob, Speakers, Auto Shut-off	E50561
	Knob, Bass, Treble, Muting, Balance	E50562-1
	Knob, Volume	E50565-1
	Knob, Tuning	E50565-2
	Yellow Jewel	I50162-2
	Lampholder, Stereo Beacon	E946-175-1
	Dress Panel Assembly	AS1164-122
	45 RPM Spindle	A50412-7
	Cartridge, Pickering	G50663
	Stylus, Replacement	G3505
	Record Changer	RC50632

### Instructions For Balancing Transistor Output Stage

- 1 — Remove power from the unit.
- 2 — Connect an 8-ohm load, a DC VTVM and the input of an IM distortion analyzer across the hot and ground contacts of the left INT SPKR output. Check that you have not shorted the amplifier output.
- 3 — Connect the output of the IM distortion analyzer to the left input.
- 4 — Switch the amplifier on and adjust the output of the distortion analyzer until the output, as measured across the load, is 5 watts.
- 5 — Adjust P1 and P2 for minimum IM distortion and zero DC across the load. The use of two screwdrivers in this procedure will save time.
- 6 — Repeat steps (2) through (5), after attaching the test equipment to the corresponding points on the right channel, and adjust P3 and P4 for zero DC and minimum IM distortion, as described above.

# P1198 SCHEMATIC DIAGRAM • AMPLIFIER

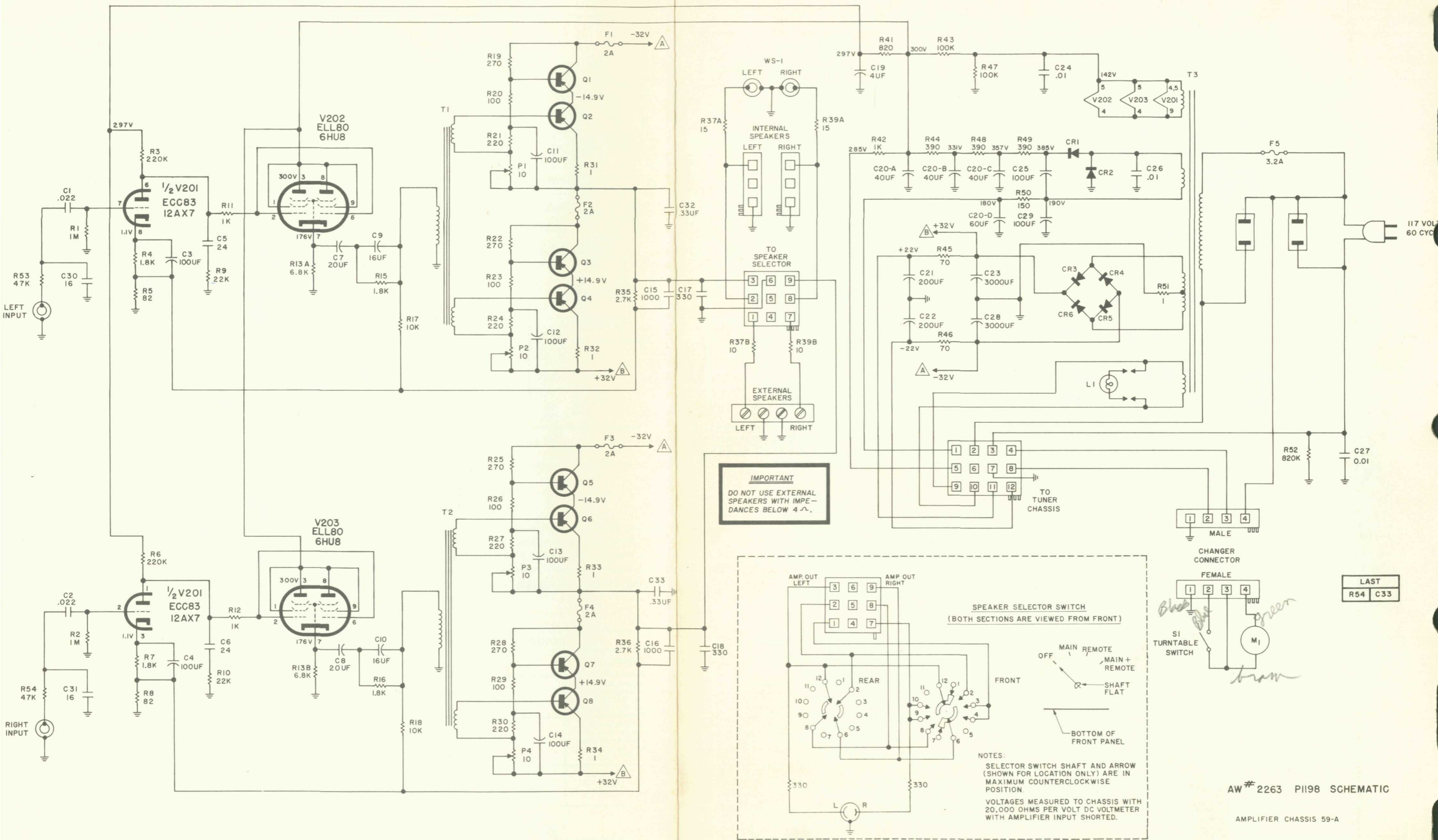

**IMPORTANT**  
DO NOT USE EXTERNAL  
SPEAKERS WITH IMPE-  
DANCES BELOW 4 Ω.

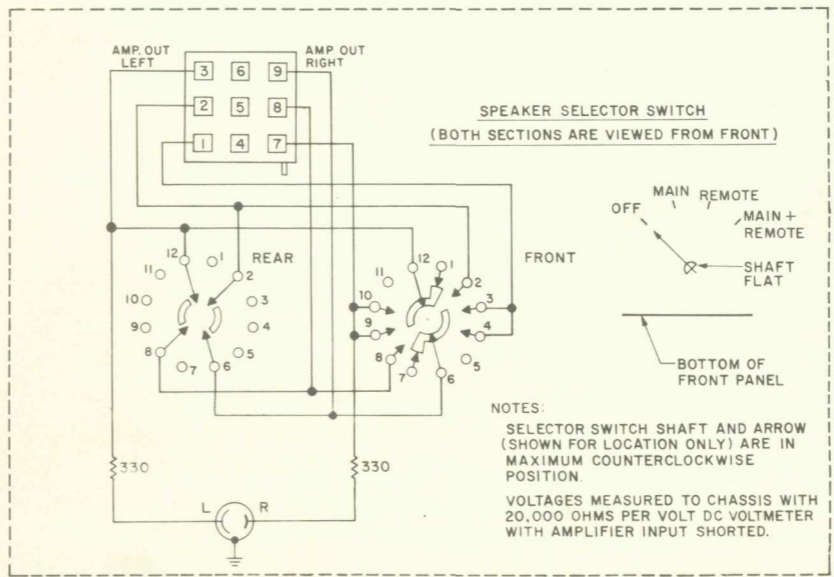

NOTES:  
SELECTOR SWITCH SHAFT AND ARROW  
(SHOWN FOR LOCATION ONLY) ARE IN  
MAXIMUM COUNTERCLOCKWISE  
POSITION.  
VOLTAGES MEASURED TO CHASSIS WITH  
20,000 OHMS PER VOLT DC VOLT-  
METER WITH AMPLIFIER INPUT  
SHORTED.

LAST  
R54 C33

AW # 2263 P1198 SCHEMATIC

AMPLIFIER CHASSIS 59-A

BECAUSE ITS PRODUCTS ARE SUBJECT TO CONTINUOUS IMPROVEMENT, FISHER RADIO CORPORATION RESERVES THE RIGHT TO MODIFY ANY DESIGN OR SPECIFICATION WITHOUT NOTICE AND WITHOUT INCURRING ANY OBLIGATION.



FISHER RADIO CORPORATION • NEW YORK